

College Point

Upgrades and Investments

September 12, 2015



College Point

College Point

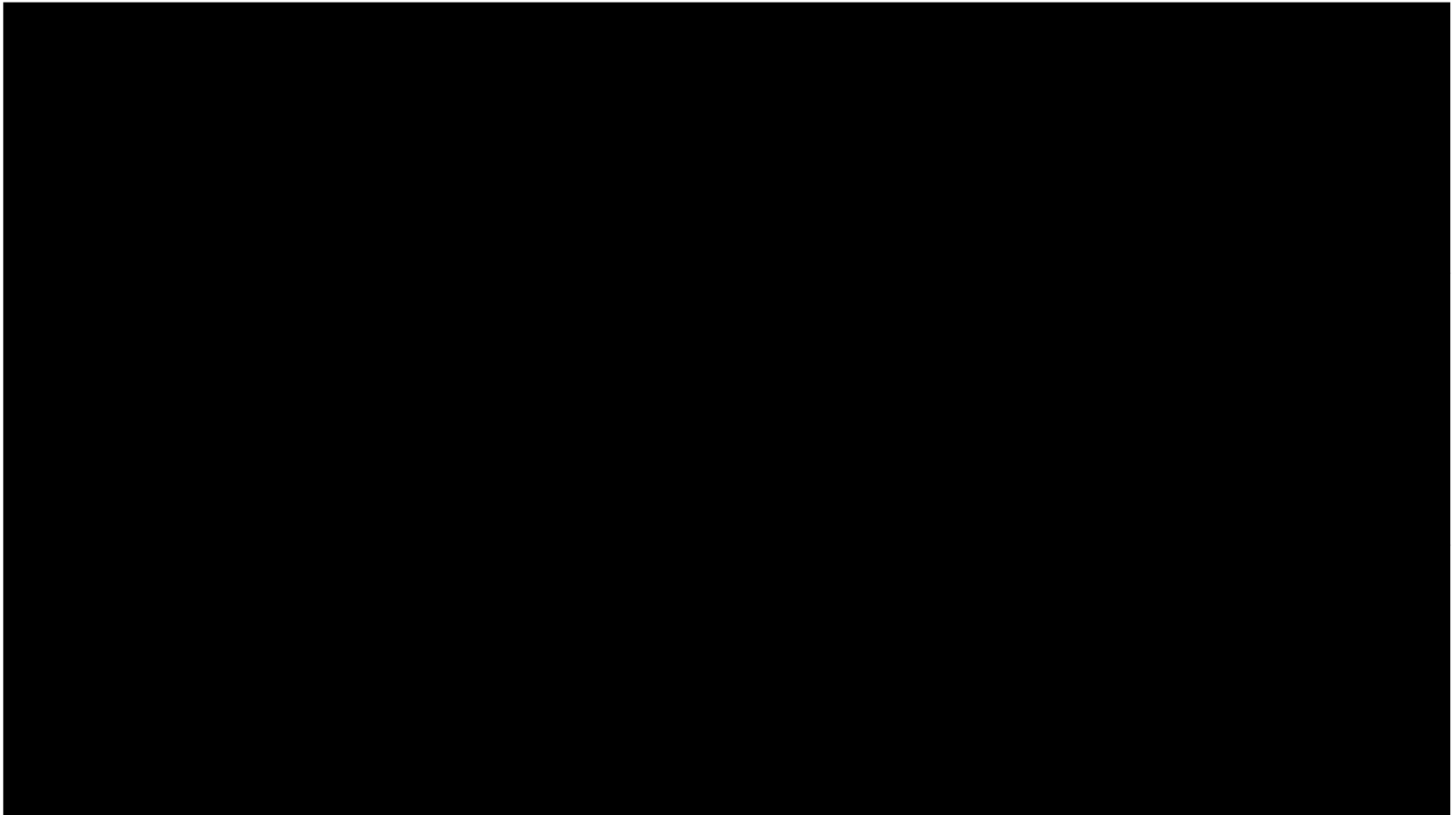

College Point

Our Mission

- Protect and Grow Print Revenue
 - Make smart strategic investments
 - Improve Quality
 - Increase Speeds
 - Lower Costs
 - Position College Point to be a Commercial Inserting and Printing option

SLS2000 Performance Enhancements



College Point

Goals of the Project

- Improve Safety
- Improve Reliability
- Improve Consistency
- Increase Net Throughput by Reducing Downtime and Improving Quality

SLS2000 Performance Enhancing Upgrades

- WinLincs 3.17
- SLS3000 Gripper
- MIRS (Missed Insert Repair System)
- SGI (Single Gripper Inhibit)
- Opener Improvements
- SLS 2000 Feeder Performance Enhancements
- Safety Guarding Upgrade



WinLincs 3.17

- Windows Embedded Standard 7 Platform
- Faster Processor
- Solid State Hard Drive
- Faster Boot up
- Improved Operator Messaging
- Faster Make-Ready
- Enhanced Reporting
- Reports can now be emailed from WinLincs
- Pocket and Gripper Performance Diagnostics
- Automatic Database backup

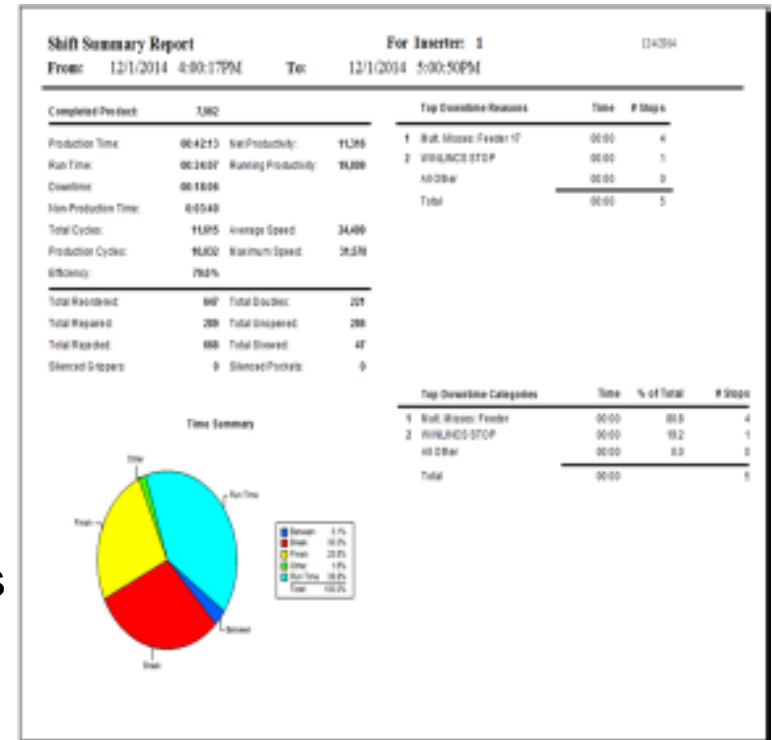

SLS3000 Gripper

- Coiled Spring Design
- No Clutch or Driver Gear
- More capacity
- No adjustments
- 3/4" Deeper Bite
- Lite Weight
- NG-A Chain



SLS3000 Gripper

The SLS3000 Gripper Upgrade includes upgrading to the NG-A Chain

NG-A



- Axle moved to pivot point for more stability in track and better geometry around the sprockets
- Larger Drive Pins (16mm)

NG-2R



- Axle in center of the link
- Smaller drive pin (12.7mm)

SLS3000 Gripper

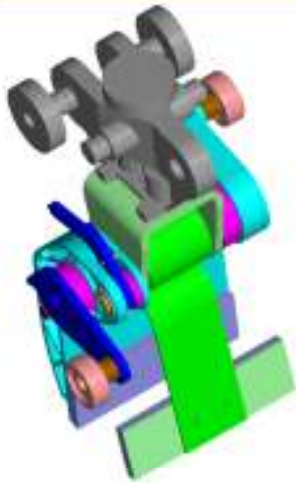

SLS3000 Gripper

- ▶ Product Capacity: 600 PG BS / 1200 PG Tab
- ▶ Gripping Length: 3.25"
- ▶ Gripping Force: Single Sheet = 1 lb
600 PG = 10 lbs
- ▶ Weight: 2.35 lbs
- ▶ Articulation: \pm 45 Degrees

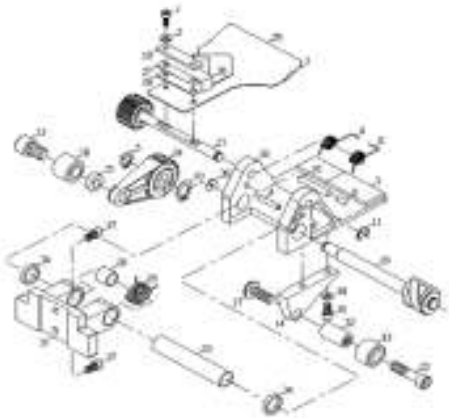

SLS2000 Gripper

- ▶ Product Capacity: 500 PG BS / 1000 PG Tab
- ▶ Gripping Length: 2.5"
- ▶ Gripping Force: Dependent on Operator
Setup (0 – 9 lb)
- ▶ Weight: 3.2 lbs
- ▶ Articulation: 0 to -45 Degrees

MIRS (Missed Insert Repair System)

- Eliminates crash point of existing design
- Old repair system was the weak point of the 2000
- Reduces critical downtime and maintenance cost
- Finger Cams are eliminated
- MIRS Pods are eliminated

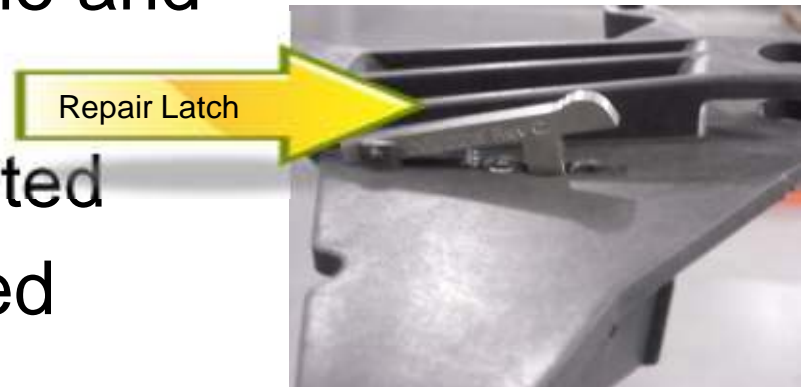
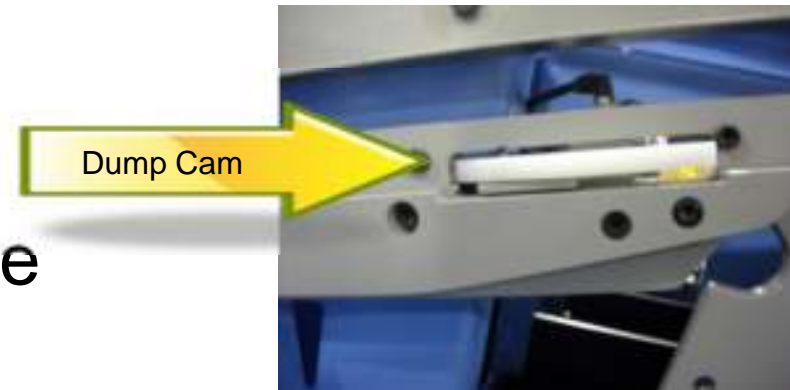

SLS3000 MIRS System

No more MIRS Pods



No more bent Finger Cams

Electronics



Two-Box Panel

- No Opto 22 Network
- No Mother/Daughter Boards
- B & R X-20 Communication
- E-Stop monitored at each Two-Box Panel
- Easy Troubleshooting
- I/O Expandable if needed

Main Electrical Cabinet

- B & R Motor Controller
- B & R X-20 PLC and Communication Network
- Single shutoff point for both 480V and 230V feeds for safety
- Stop reasons clearly and individually identified



SGL (Single Gripper Inhibit)

- Improves repair process by only opening the jacket once.
- Improves product quality.
- Reduces waste.
- Reduces hangers and rejects.

Opener Improvements

Motorized Stream Aligner

- Old design was high wear item.
- Reduce maintenance costs.
 - Improved performance



Line Shaft Driven Vacuum Shuttle

- Old design was high wear item.
- Improved productivity with more consistent opening.
 - Reduce maintenance costs.

Pulsed Air Bar

- Improved performance on smaller page count jackets
- Increased net throughput
- Improved product quality



Feeder Performance Enhancements

- Feeder Rebuild/Upgrade Exchange
- Light Pole Indicates Miss/Double/Online
- Improved Sucker Bar Cam Reduces Misses
- Enhanced Carry down Assembly
- Improves Delivery of Insert to Pocket
- Upgraded Inhibit latch for longer life
- Improved Miss/Double/Jam Detection

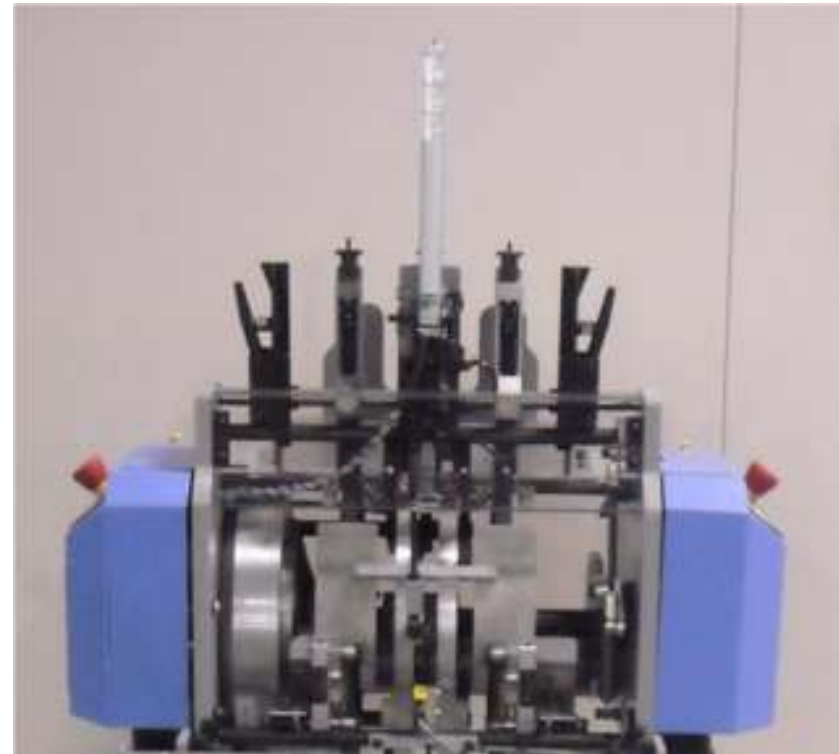

Safety Guarding Upgrades

- Upgraded to Class 3 Redundancy Idler
- Opener and Drive End Doors Inter-locked
- Key Switches Replace Magnetic Switches
- Feeder Pods Now Interlocked
- LED indicators at 2-box sections

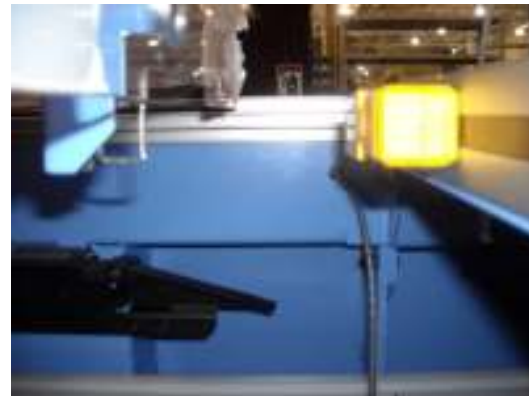

Project Timeline



Thank you!



College Point